

A. Read instructions thoroughly. Acquaint yourself with the inventory of parts and the accompanying drawings to ensure safety and proper assembly.







B. You will need the following tool



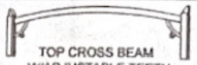

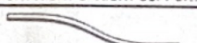
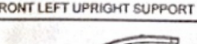
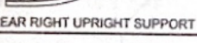



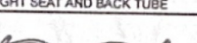
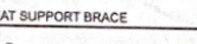
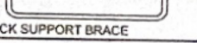

-Phillips Screwdriver

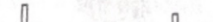

C. Lay out all parts and identify using the table below.

PARTS LIST

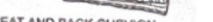
PART NO.	MATERIAL CODE	PART	Q'TY
1	RUS4098-CS01	 TOP CROSS BEAM W/ADJUSTABLE TEETH	1
2	RUS4098-CS02	 FRONT RIGHT UPRIGHT SUPPORT	1
3	RUS4098-CS03	 FRONT LEFT UPRIGHT SUPPORT	1
4	RUS4098-CS04	 REAR RIGHT UPRIGHT SUPPORT	1
5	RUS4098-CS05	 REAR LEFT UPRIGHT SUPPORT	1
6	62RUS4098C101	 LEFT SEAT AND BACK TUBE	1
7	62RUS4098C201	 RIGHT SEAT AND BACK TUBE	1
8	62RUS4098C102	 SEAT SUPPORT BRACE	1
9	62RUS4098C103	 BACK SUPPORT BRACE	1
10	62RUS4098M101	 FRONT SWING ARM TUBE	2
11	62RUS4098M102	 REAR SWING ARM TUBE	2

PART NO.	MATERIAL CODE	PART	Q'TY
12	RUS4098-CS06	 REAR CROSS BRACE	1
13	RUS4098-CS07	 LATERAL CROSS BRACE	2
14	RUS4098-CS08	 REAR SUPPORT BRACE	1
15	62RUS4098I102	 FRONT/REAR CANOPY BRACE	2
16	62RUS4040H102	 SIDE CANOPY BRACE	2
17	1802623003	 CANOPY/FRAME CONNECTOR	2
18	17C17A0403001Y4	 SCREW ST4 2" x 12"	4
19	1800018001	 PLASTIC SCREW	2
20	17GC06042401	 SUSPENSION SPRING	2
21	61R4098C00001BA	 SEAT AND BACK CUSHION	1
22	61R4098D00001BA	 CANOPY	1



DON'T RETURN TO STORE!

Step 1: Align the upright supports. Insert the rear right upright support(#4) into the front right upright support(#2). Do the same procedure for the other side (#3, #5). See Fig. A-step 1.

NOTE: Make sure the number labels marked "2, 3, 4, 5" on the upright supports should be coincided with the numbers in Fig. A to ensure proper assembly.

Step 2: Attach the top cross beam(#1) to both ends of the upright supports. Make sure the spring buttons on the rear upright supports(#4, #5) come through the holes on the top cross beam(#1). See Fig. A-step 2.

Step 3: Fasten the lateral cross braces(#13) to the upright supports(#2, #3, #4 and #5) for both sides. Lock the rear cross brace(#12) to the rear upright supports(#4, #5). See Fig. A-step 3.

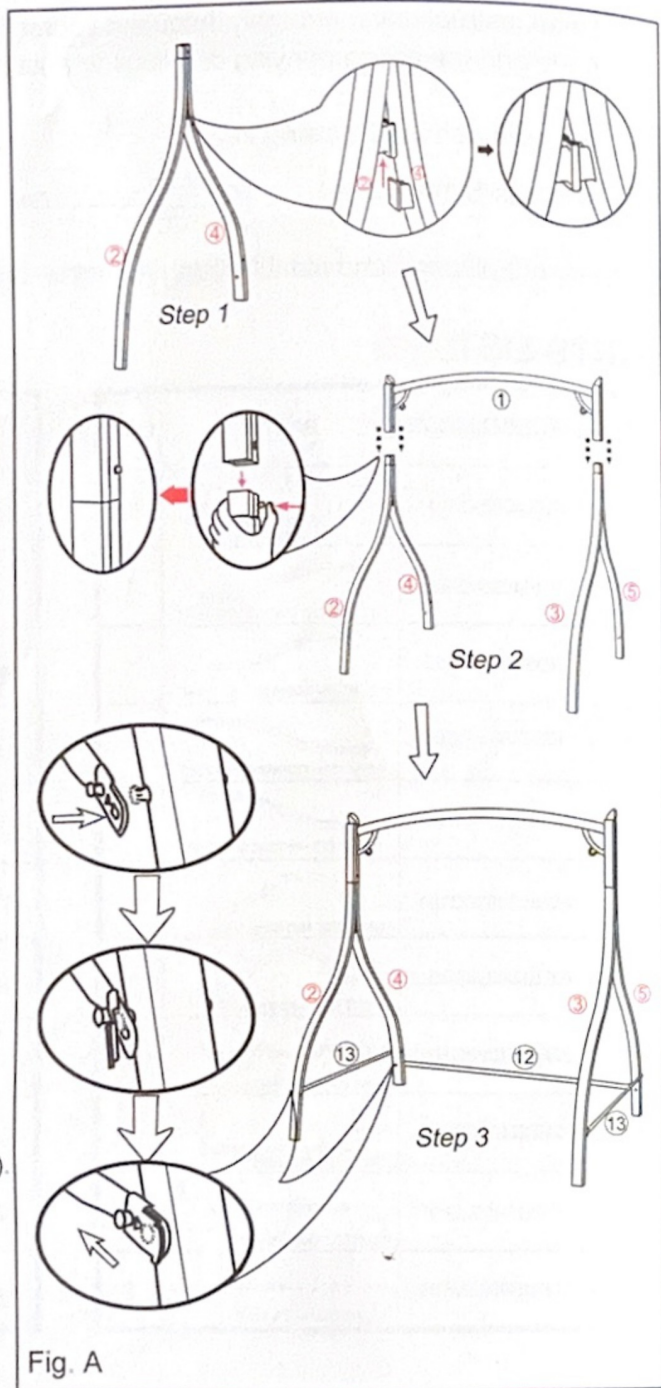

STOP DON'T RETURN TO STORE!

Step 4: Position the seat and back cushion(#21) on a non-abrasive surface, such as a carpet, then unfold the cushion, with the underside facing up. See Fig. B.

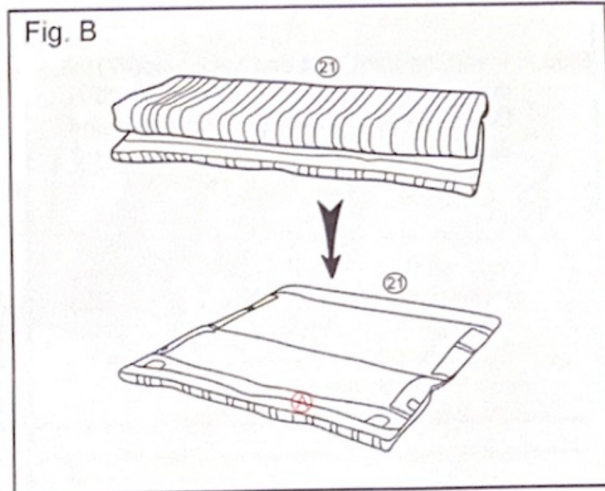

Step 5: Insert the seat support brace(#8) into the seat sleeve of the seat and back cushion (#21). See Fig. C.

NOTE: Make sure the seat support brace insert into seat sleeve marked "A". See Fig. C-step 1. The two arcs of the seat support brace should be facing up. See Fig. C-step 2.

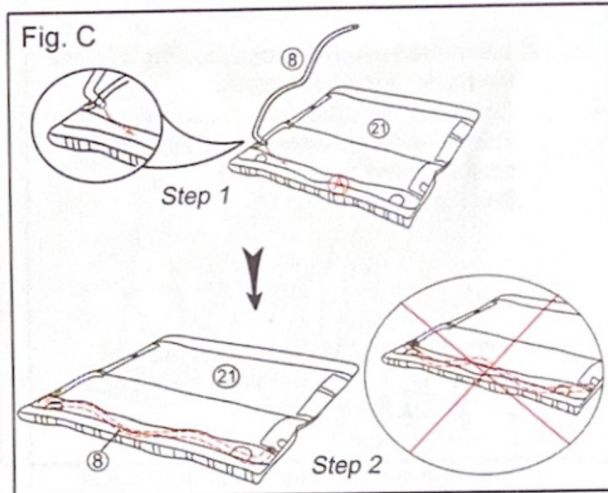

Step 6: Insert the back support brace(#9) into the back sleeve of the cushion(#21). See Fig. D.

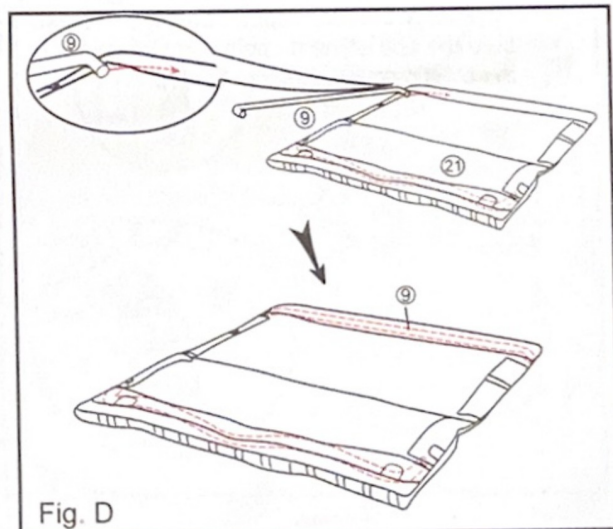

DON'T RETURN TO STORE!

Step 7: Insert the right seat and back tube(#7) into the right side sleeves of the cushion(#21). Do the same procedure for the other side. See Fig. E.

NOTE:

1. Make sure the number labels marked "6, 7" on the seat and back tubes(#6, #7) should be coincided with the numbers in Fig. E to ensure proper assembly.
2. Make sure that the welded parts on the seat and back tubes should be facing outwards. See Fig. F-illustration A.

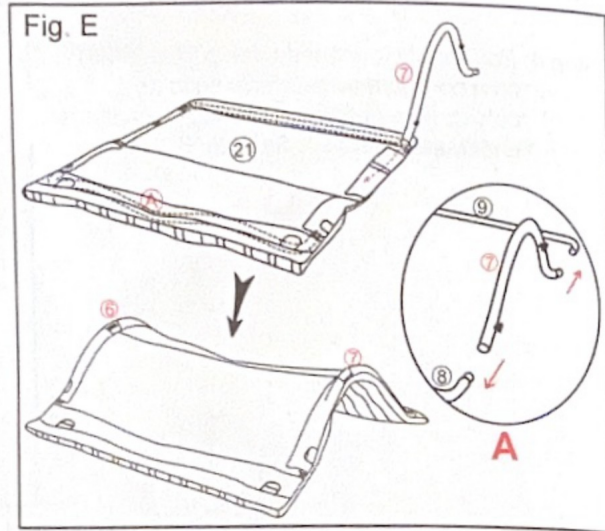

Step 8: Insert the seat and back tubes(#6, #7) into the back support brace(#9). See Fig. F-illustration B. Insert the seat support brace(#8) into the seat and back tubes(#6,#7). See Fig. F-illustration C.

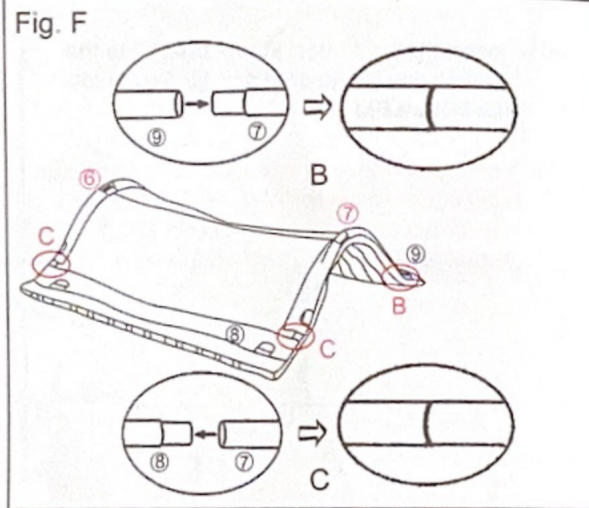

Step 9: Insert the two ends of the rear support brace(#14) into the slots of the seat and back tubes(#6, #7). See Fig. G-step 1.

Press the spring button, slide the thimble attached on the rear support brace(#14) to the joint of the rear support brace, and make sure the end of the thimble come close with the plastic cover. See Fig. G-step 2.

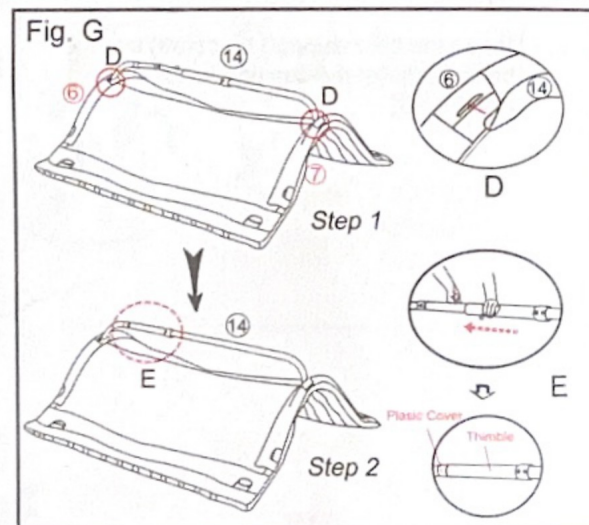

STOP DON'T RETURN TO STORE!

Step 10: Attach the swing arm tubes(#10, #11) to the welded parts of the seat and back tubes(#6,#7). See Fig. H.

NOTE: Make sure the longer swing arm tubes(#10) attached on the seat parts of the tubes (#6, #7).

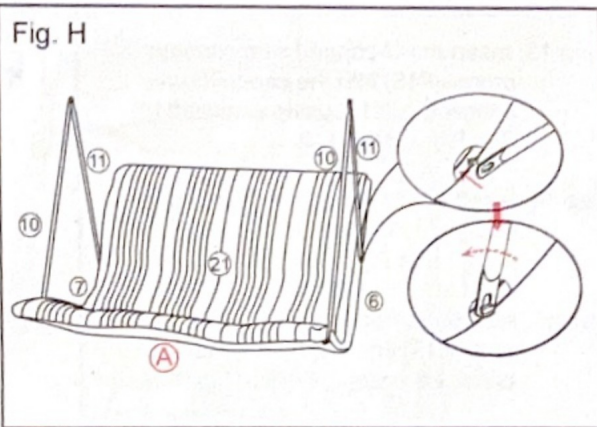

Step 11: Hook the suspension spring(#20) into the holes at the top of both swing arm tubes (#10, #11). Do the same procedure for the other side. See Fig. I.

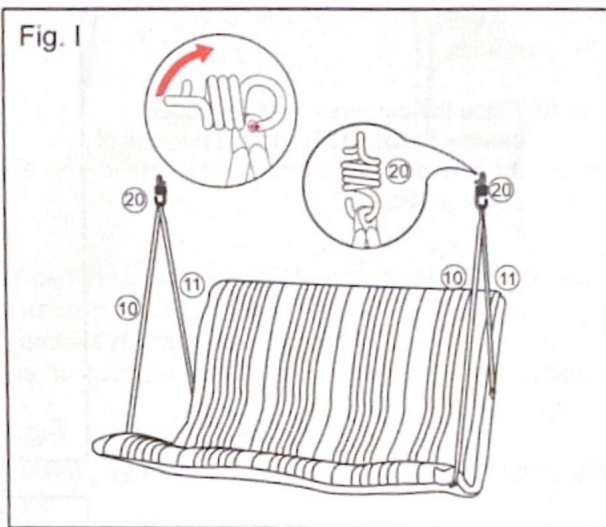

Step 12. Hang the suspension spring(#20) into the hole on the angled brace located on the top cross beam(#1). Do the same procedure for the other side. See Fig J.

Warning: Make sure that both ends of the suspension springs go completely through the angled braces on part(#1) and the swing arm tubes(#10, #11).

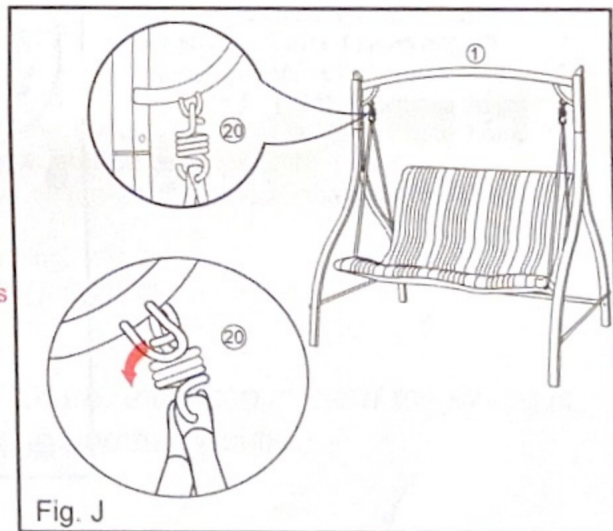

DON'T RETURN TO STORE!

Step 13: Insert the U-shaped side canopy braces(#16) into the canopy/frame connectors(#17) using screws(#18). See Fig. K-step 1, 2.

Step 14: Insert the front and rear canopy braces (#15) into the sleeves of the canopy (#22). See Fig. K-step 3.

Step 15: Attach the front and rear canopy tube ends(#15) into the U-shaped side canopy braces(#16). See Fig. K-step 4.

NOTE: Make sure that the teeth of the canopy/ frame connectors(#17) are facing inwards.

Step 16: Place the corners of the U-shaped canopy braces(#16) into the pockets of the canopy(#22). See Fig. K-step 5.

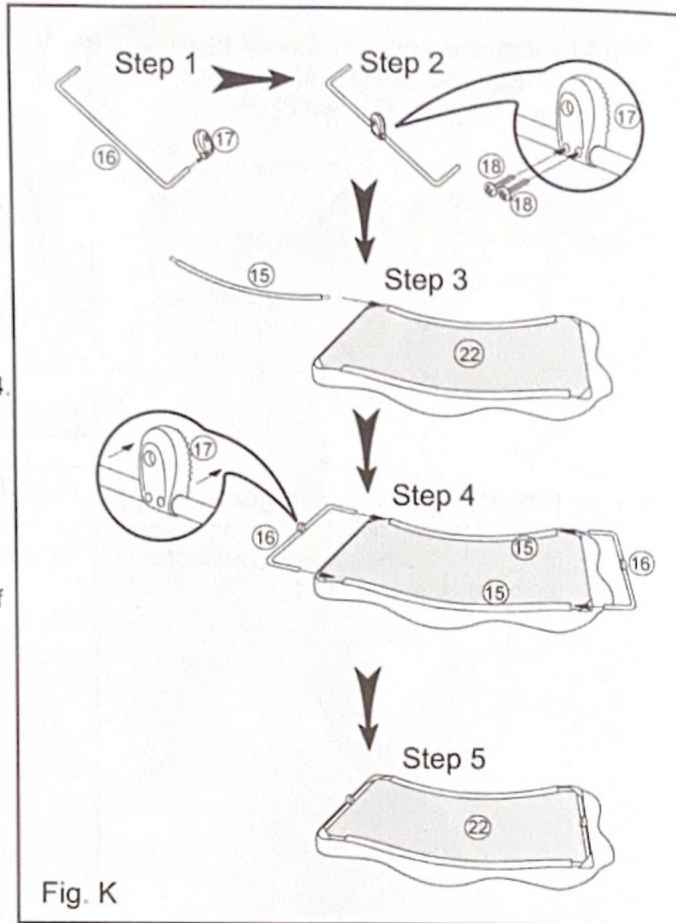

Fig. K

Step 17: Attach the canopy assembly onto the adjustable teeth located on both sides of the top cross beam(#1) using the plastic screws(#19) into the canopy/ frame connectors(#17). See Fig. L.

Step 18: See full assembly.

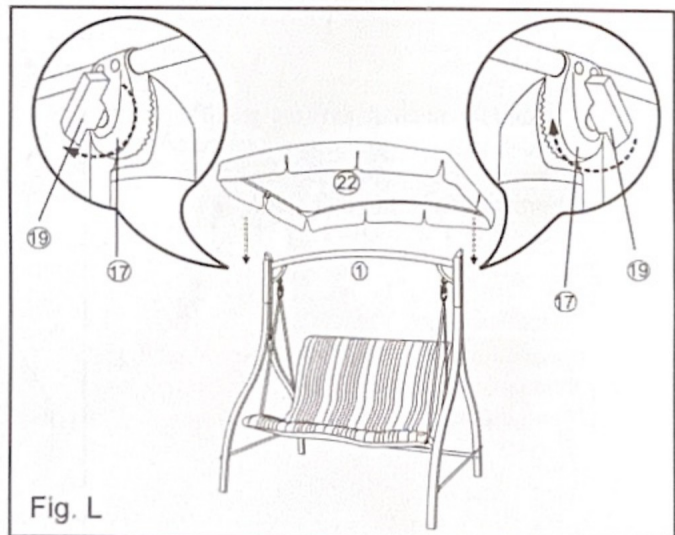

Fig. L



DON'T RETURN TO STORE!

CONGRATULATIONS!!

To avoid danger of suffocation, please always keep plastic bags or small parts away from babies and children.



Cleaning and Maintenance

- Wash frame parts with mild soap and water, rinse thoroughly. Dry frame completely. Do not use bleach, acid or other solvents on the fabric or frame parts.
- We recommend the use of furniture covers to protect your swing when not in use.
- Please inspect and tighten all bolts or fasteners on a regular basis to ensure proper performance and safety of your swing.
- Oil all metallic moving parts during usage season.
- In order to prolong the life and beauty of your swing, we recommend that the swing be stored in a dry and protected area during off season periods.

Special Warnings

- The user of this swing should always inspect it before each use.
- It is essential to place the swing on level ground and not less than six feet from any obstruction, such as fences, garages, house, overhanging branches, laundry lines or electrical wires.
- Check the tightness of nuts and bolts on a regular basis.
- Ensure that the suspension springs are properly hooked before each use.
- Remove the canopy in heavy wind conditions; otherwise, the canopy may tip over and cause damage to its parts.
- Oil all metallic moving parts during usage season.
- The manufacturer will not accept responsibility for unauthorized repairs or modifications made to the swing.
- Weight limit is 500 lbs.

Retain the assembly instructions for future reference, in case the swing is disassembled for storage or to move to another location.



DON'T RETURN TO STORE!